



















# Cresco API™ for Screw-Vent™

Platform Ø 3.5 mmD, Green		Cresco API™	REF 30371	REF 30571	REF 30871
Prosthetic Components		Laboratory Components		Includes Bridge Support in	
Impression Element and Pin 	Bridge Screw 	Replica 	Process Screw 	Wax Tube 	Titanium 
				Burnout 	Cobalt-Chrome 

Platform Ø 4.5 mmD, Purple		Cresco API™	REF 30372	REF 30572	REF 30872
Prosthetic Components		Laboratory Components		Includes Bridge Support in	
Impression Element and Pin 	Bridge Screw 	Replica 	Process Screw 	Wax Tube 	Titanium 
				Burnout 	Cobalt-Chrome 

# Cresco™ restorative instruments for Screw-Vent™

## Screwdrivers

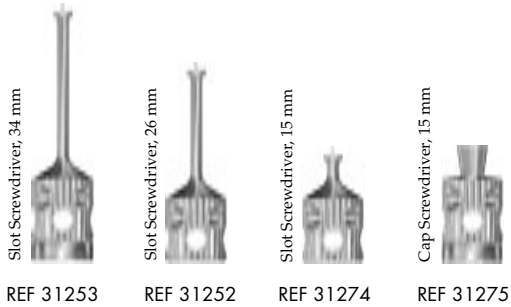

REF 31253    REF 31252    REF 31274    REF 31275



REF 31254    Slot Screwdriver, Long

## RA Screwdrivers

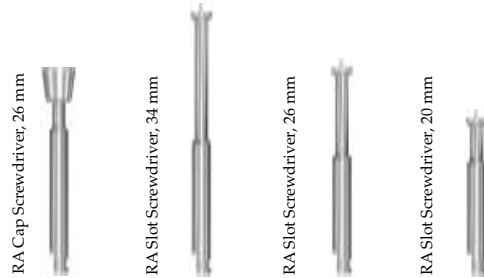

REF 31251    REF 31264    REF 31272    REF 31273

## Instruments

REF 31276



Torque Ratchet Wrench with individual adjustment of the torque to 15, 20 and 35 Ncm

REF 31248



Counter Torque Key, flat grip

REF 22437



Forceps titanium, 94 mm

Vent™ is a trademarks of Zimmer Dental INC, USA.

Cresco™ and Cresco API™ are trademarks of Astra Tech AB, Sweden.

